

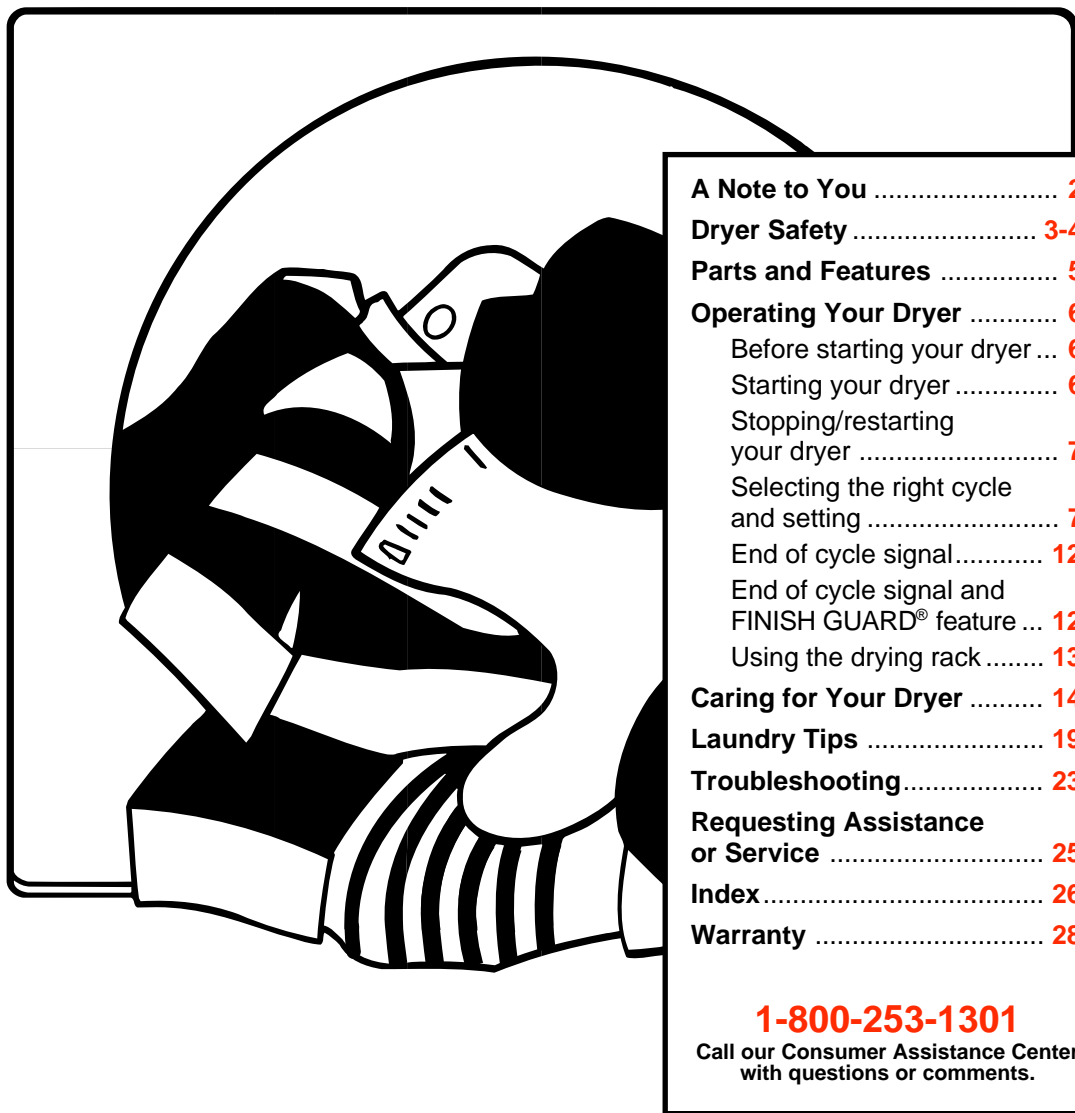

HOW TO MAKE A HOME RUN.™

Use And Care

G U I D E



A Note to You	2
Dryer Safety	3-4
Parts and Features	5
Operating Your Dryer	6
Before starting your dryer ...	6
Starting your dryer	6
Stopping/restarting your dryer	7
Selecting the right cycle and setting	7
End of cycle signal.....	12
End of cycle signal and FINISH GUARD® feature ...	12
Using the drying rack	13
Caring for Your Dryer	14
Laundry Tips	19
Troubleshooting.....	23
Requesting Assistance or Service	25
Index.....	26
Warranty	28

1-800-253-1301

Call our Consumer Assistance Center with questions or comments.

ELECTRIC AND GAS DRYERS

A Note to You

Thank you for buying a WHIRLPOOL® appliance.

Because your life is getting busier and more complicated, WHIRLPOOL dryers are easy to use, save time, and help you manage your home better. To ensure that you enjoy years of trouble-free operation, we developed this Use and Care Guide. It contains valuable information about how to operate and maintain your dryer properly and safely. Please read it carefully. Also, please complete and mail in the Ownership Registration Card provided with your appliance. The card helps us notify you about any new information on your appliance.

Please record your model's information.

Whenever you call to request service on your appliance, you need to know your complete model number and serial number. You can find this information on the model and serial number label (see diagram on page 5 for location of label).

Please also record the purchase date of your appliance and your dealer's name, address, and telephone number.

Model Number _____

Serial Number _____

Purchase Date _____

Dealer Name _____

Dealer Address _____

Dealer Phone _____

Keep this book and the sales slip together in a safe place for future reference.

**Our Consumer Assistance Center
number is toll-free.**

1-800-253-1301

Dryer Safety

Your safety is important to us.

This guide contains safety statements under warning symbols. Please pay special attention to these symbols and follow any instructions given. Here is a brief explanation of the use of the symbol.



This symbol alerts you to hazards such as fire, electrical shock, or other injuries.

WARNING: For your safety, the information in this manual must be followed to minimize the risk of fire or explosion, or to prevent property damage, personal injury, or loss of life.

- Do not store or use gasoline or other flammable vapors and liquids in the vicinity of this or any other appliance.
- **WHAT TO DO IF YOU SMELL GAS:**
 - Do not try to light any appliance.
 - Do not touch any electrical switch; do not use any phone in your building.
 - Clear the room, building, or area of all occupants.
 - Immediately call your gas supplier from a neighbor's phone. Follow the gas supplier's instructions.
 - If you cannot reach your gas supplier, call the fire department.
- Installation and service must be performed by a qualified installer, service agency, or the gas supplier.

continued on next page

IMPORTANT SAFETY INSTRUCTIONS

WARNING – To reduce the risk of fire, electric shock, or injury to persons when using the dryer, follow basic precautions, including the following:

- Read all instructions before using the dryer.
- Do not dry articles that have been previously cleaned in, washed in, soaked in, or spotted with gasoline, dry-cleaning solvents, other flammable, or explosive substances as they give off vapors that could ignite or explode.
- Do not allow children to play on or in the dryer. Close supervision of children is necessary when the dryer is used near children.
- Before the dryer is removed from service or discarded, remove the door to the drying compartment.
- Do not reach into the dryer if the drum is moving.
- Do not install or store the dryer where it will be exposed to the weather.
- Do not tamper with controls.
- Do not repair or replace any part of the dryer or attempt any servicing unless specifically recommended in this Use and Care guide or in published user-repair instructions that you understand and have the skills to carry out.
- Do not use fabric softeners or products to eliminate static unless recommended by the manufacturer of the fabric softener or product.
- Do not use heat to dry articles containing foam rubber or similarly textured rubber-like materials.
- Clean lint screen before or after each load.
- Keep area around the exhaust opening and adjacent surrounding areas free from the accumulation of lint, dust, and dirt.
- The interior of the machine and exhaust duct should be cleaned periodically by qualified service personnel.
- See Installation Instructions for grounding requirements.

SAVE THESE INSTRUCTIONS

Parts and Features

The parts and features of your dryer are illustrated below. Become familiar with all parts and features before using your dryer. Page references are included next to some features. Refer to those pages for more information about the features.

NOTE: The drawings in this book may vary from your dryer model. They are designed to show the different features of all models covered by this book. Your model may not include all features.

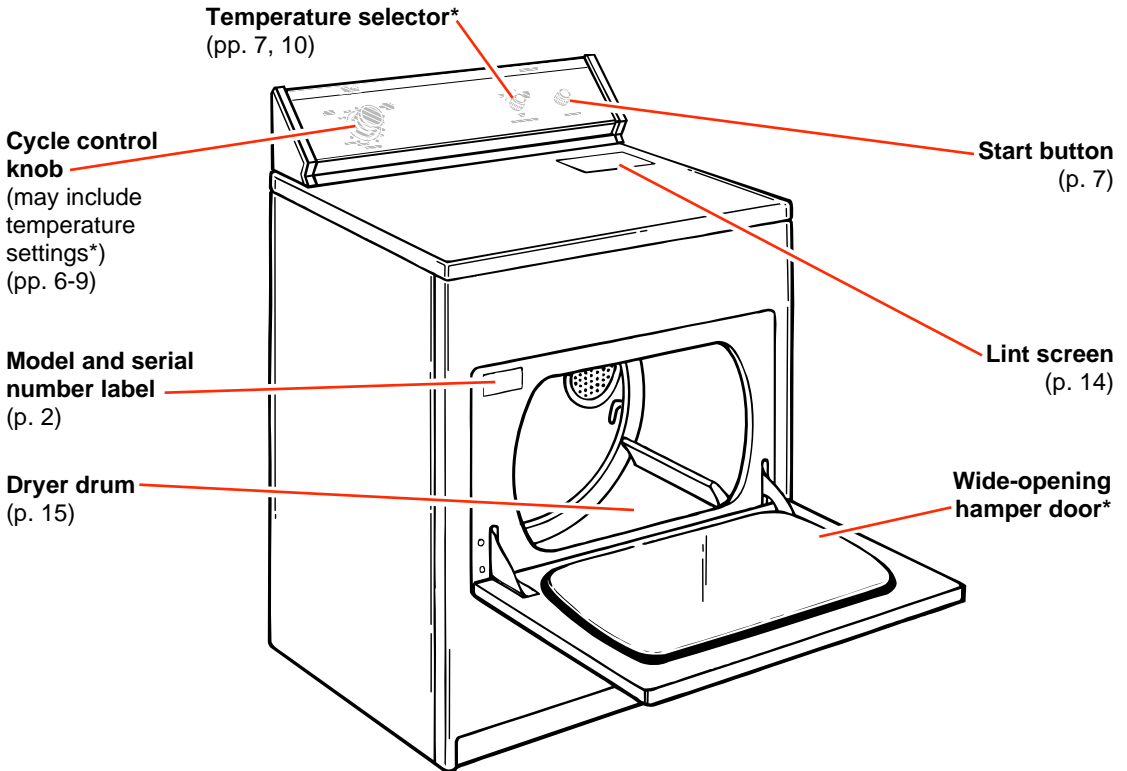

Other doors:

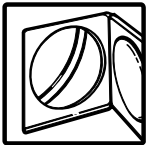

Small side-swing door*
Large side-swing door*
(Reversible door – see
Installation Instructions)



Full-width hamper door*

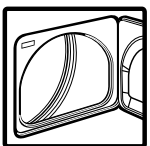

Super wide-opening door*
(Reversible door – see
Installation Instructions)

Additional features your dryer may have:

End of cycle signal selector (p. 12)
FINISH GUARD® feature selector (p. 12)
Drying rack (p. 13)
Lint signal (p. 15)
Drum light (p. 16)

*On some models

Operating Your Dryer

The information in this section helps you learn to use your dryer efficiently and safely. Refer to “Laundry Tips” on page 19 for additional information on sorting, loading, and drying most types of washables.

NOTES:

- Make sure your dryer is properly vented before using it. See warning below and your Installation Instructions.
- Make sure your dryer is properly installed in a well-ventilated room where the temperature is above 45°F (7°C).
- Make sure your dryer is leveled on a floor that can support the weight.

! WARNING



Fire Hazard

Use a heavy metal vent.
Do not use a plastic vent.
Do not use a metal foil vent.
Failure to do so can result in death or fire.

! WARNING



Explosion Hazard

Never place items in the dryer that are dampened with gasoline or other flammable fluids.

Do not wash or dry items soiled with vegetable or cooking oils because they may contain some oil after laundering.

Doing so can result in death, explosion, or fire.

Before starting your dryer

Before using your dryer, wipe the dryer drum with a damp cloth to remove dust from storing and shipping.



Your dryer may have a Dryer Features Guide (usually located on top of the dryer). Remove it and place it with your Use and Care Guide. The Features Guide provides you with more information about your dryer.

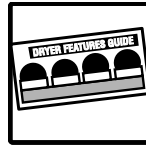

Starting your dryer

1. Load clothes into the dryer and close the door.



2. Turn the Cycle Control Knob to the desired cycle. Use the Energy Preferred Automatic Setting (*) to dry most loads (see page 8).



3. If your dryer has a Temperature Selector, set it to the desired setting (see page 10). Some dryer models have either a rotary knob or tap touch Temperature Selector.

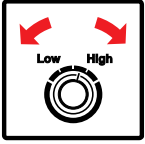

4. Push the Start Button.



NOTE: Your dryer stops automatically when a cycle ends.

Stopping/restarting your dryer

You can stop your dryer anytime during a cycle.

To stop the dryer, either:



- Open the dryer door.

OR



- Turn the Cycle Control Knob to Off.

To restart the dryer:

1. Close the door.
2. Select a new cycle and temperature (if desired).
3. Push the Start Button.



NOTE: The Cycle Control Knob should point to an Off area when the dryer is not in use.

Selecting the right cycle and setting

The following pages describe the cycles on your dryer. Refer to the charts on pages 10-11 for help in selecting drying cycles.

Drying guidelines

- Always follow care label directions when they are available.
- The last few minutes of all cycles are without heat to make the load cooler to handle.
- To help reduce wrinkling, remove the load from the dryer as soon as tumbling stops. This is especially important for permanent press, knits, and synthetic fabrics.
- Overdrying can cause shrinkage, static cling, and damage to some fabrics.
- Refer to pages 19-22 for information about:
 - sorting clothes for drying
 - choosing load sizes
 - drying tips
 - using dryer fabric softener sheets
 - saving energy
 - drying special-care items.

continued on next page

Cycle descriptions

Automatic Cycle(s)

Dry most loads using the Energy Preferred Automatic Setting (*). Your

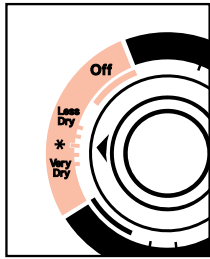

Automatic cycle(s) shuts off when the selected dryness is reached. The Cycle Control Knob will not move until the load is almost dry. After the cool-down, the Knob automatically turns to an Off area and tumbling stops.

- If the load is drier than you like, select a setting closer to Less Dry the next time you dry a similar load.
- If the load is not as dry as you like, complete drying using a Timed cycle. Select a setting closer to Very Dry the next time you dry a similar load.

Some models offer high heat and low heat Automatic cycles (see page 10).

NOTES:

- Some Automatic cycles use an **electronic DRY-MISER®** control that senses the amount of moisture in the load.
- Other Automatic cycles use an **automatic DRY-MISER** control that senses the exhaust temperature and determines the dryness of the load.

Timed Cycle(s)

Use a Timed cycle to complete drying if some items are damp after Automatic drying. Timed drying is also useful for:

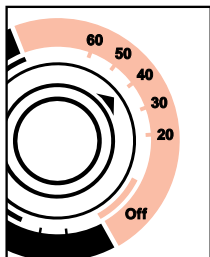

- Delicate items and small loads that need a short drying time.
- Bulky items and large loads that require a long drying time.

Some models offer high heat and low heat Timed cycles (see page 10).

Fluff Air Cycle (on some models)

The Fluff Air cycle has no heat. Use this unheated cycle to fluff or air dry bedding, plastic tablecloths, foam pillows, sneakers, etc. See page 11 for more information about the Fluff Air cycle.

NOTE: If your model does not have the Fluff Air cycle, line dry heat-sensitive items.

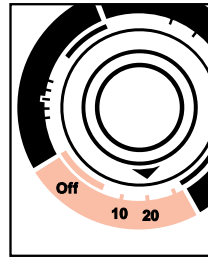

Heavy Dry Cycle (on some models)

Use Heavy Dry and a high heat setting to dry large items or items that are thicker or heavier than a regular load (such as heavy cotton bath towels or robes).

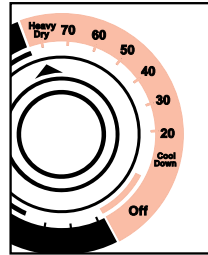

Damp Dry Cycle (on some models)

Use Damp Dry to dry items to damp level or to dry items that do not require an entire drying cycle. Two examples are heavy cottons, such as jeans, which you do not want to become stiff, or cotton clothes which are easier to press when damp.

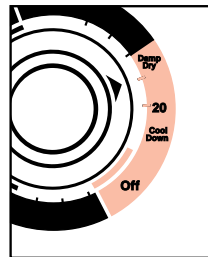

TUMBLE PRESS® Cycle (on some models)

The TUMBLE PRESS cycle removes wrinkles from clothes that have been packed in a suitcase or closet, or from items not removed from the dryer at the end of a cycle. As soon as the dryer stops, fold or put the items on hangers.

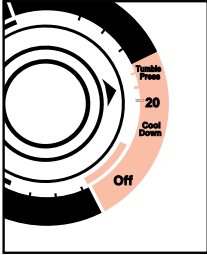

Towels Feature (on some models)

When you have large loads of towels to dry, you may want to use the Towels feature in the Automatic cycle. The Towels setting allows for more drying time and automatically shuts off the dryer when the selected dryness is reached. The Towels feature also can be used for extra heavy items such as mattress pads and quilts.

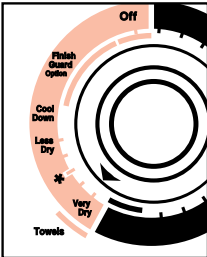

Rack Dry Feature (on some models)

You may want to dry some items without tumbling (such as wool sweaters, stuffed toys, or pillows). Use the drying rack (see page 13) and the Rack Dry feature for these items, and a low temperature setting. During the drying cycle, the drum turns, but the rack does not move. Drying time depends on the amount of moisture in the items.

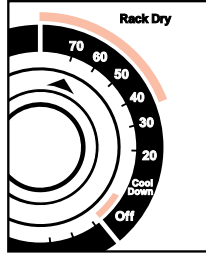

NOTES:

- Be sure to follow the instructions on page 13 for installing the drying rack in your dryer and placing items on the rack.
- Use the chart on page 13 to determine temperatures and drying times.
- You may use either the Timed cycle or Fluff Air cycle for rack drying.

FINISH GUARD® Feature (on some models)

When you are unable to remove a load from the dryer as soon as it stops, wrinkles can form. The FINISH GUARD feature tumbles the load without heat every few minutes up to 45 minutes after the cycle ends. This tumbling rearranges and fluffs the load to avoid wrinkles. You do not have to set the Cycle Control Knob for the FINISH GUARD feature. If you do not open the dryer door within a few minutes after the cycle stops, the FINISH GUARD feature takes over to protect the load.

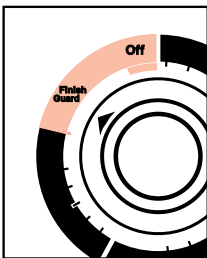

A signal sounds every few minutes when FINISH GUARD is running. The signal and cycle stop when you open the dryer door.

NOTE: See page 12 if your model has a FINISH GUARD On/Off selector.

Drying cycles chart

Use the chart below to help you make drying selections. The chart suggests heat settings and drying times for various loads.

NOTES:

- Use an Automatic cycle to dry most loads.
- Use a Timed cycle only if the recommended Automatic cycle is not available.

- The check mark (✓) in the chart below denotes recommended temperature settings. If some types of loads in the chart have more than one suggested temperature setting, choose the lowest setting available on your dryer.
- Always follow care label directions when they are available.

TYPE OF LOAD	AUTOMATIC CYCLE (heat settings)				TIMED CYCLE (minutes)	
	High	Medium*	Low	Extra Low*	High	Low
COTTONS AND LINENS Extra Heavy Bedspreads, mattress pads, quilts Heavyweight Towels, jeans, corduroys, work clothes Mediumweight Sheets, cotton underwear, diapers Lightweight Batistes, organdies, lingerie	✓				70-80	
	✓				50-60	
	✓	✓			40-50	
			✓			20-30
PERMANENT PRESS, SYNTHETICS, AND BLENDS Heavyweight Work clothes, jackets, raincoats Mediumweight Shirts, play clothes, sheets, slacks Lightweight Lingerie, blouses, dresses	✓				40-50	
	✓	✓			30-40	
			✓			20-30
KNITS Heavyweight Cottons, rayons, blends, T-shirts, slacks, shirts Mediumweight Synthetics (polyester, acrylic, etc.), dress slacks, skirts, sweaters Lightweight Synthetics (polyester, acrylic, etc.) and blends, lingerie, blouses, dresses	✓				40-50	
		✓				30-40
			✓	✓		20-30
DELICATES** Sheer curtains (2 or 3 panels), gauze, lace, etc.			✓	✓		15-20

* Settings available only on dryer models with separate Temperature Selector.

** If you don't have low or extra low heat, use Fluff Air cycle (if available). Line drying is also recommended for delicate fabrics.

End of cycle signal (on some models)

The dryer sounds a signal to let you know when the cycle is finished. The signal is helpful when you are drying permanent press, synthetics, and other items that should be removed from the dryer as soon as it stops. The End of Cycle On/Off Selector is part of the Start Button, as shown.

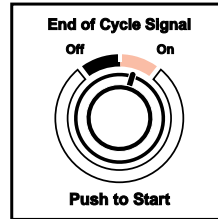

NOTE: Unless you turn the Selector to Off, the end of cycle signal sounds at the end of the drying cycle.

End of cycle signal and FINISH GUARD® feature (on some models)

You can turn the End of Cycle signal and FINISH GUARD feature on and off.

NOTE: Unless you turn Off the Selectors for the FINISH GUARD feature and End of Cycle signal, they operate at the end of the drying cycle.

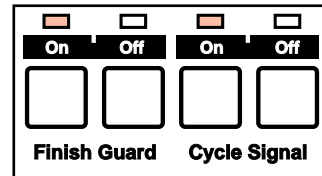

CLEAN TOUCH™ panel

OR

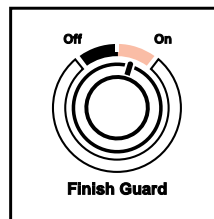

Rotary knob

Using the drying rack (Available as an option on some models)

To order drying rack, call: **1-800-253-1301**. You will hear a recording. Follow the steps to place an order.

The drying rack lets you dry items that you may not want to tumble. The rack does not move, but the drum turns.

1. Fit rear legs of the rack into indentations in the back wall of the dryer. Lower the front so the legs rest on the dryer opening.

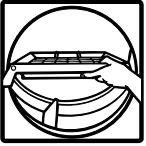

2. Put wet items on top of the rack. Leave space between the items so air can reach all surfaces.
NOTE: Make sure nothing hangs over the edge of the rack.



3. Close the door.



4. Select the Timed drying cycle (and temperature, if needed) or the Fluff Air cycle (see page 11).
5. Push the Start Button.



NOTES:

- See the chart below for suggested cycles and settings for the different types of items that might best be rack dried.
- The rack must be removed for normal tumbling.
- Drying time will depend on how much moisture the items hold. The following chart suggests drying times.
- Automatic cycles do not work with the drying rack.

RACK DRY	CYCLE	TEMPERATURE	TIME* (minutes)
Wool sweaters (Block to shape and lay flat on the rack)	Timed	Low or Extra Low	60
Stuffed toys or pillows (Cotton or polyester fiber filled)	Timed	Low or Extra Low	60
Stuffed toys or pillows (Foam rubber filled)	Fluff Air	None; cycle is unheated.	90
Sneakers or canvas shoes	Fluff Air	None; cycle is unheated.	30-40

* Reset cycle as needed to complete drying.

Caring for Your Dryer

Proper care of your dryer can extend its life. This section explains how to care for your dryer properly and safely.

Cleaning the lint screen

Every load cleaning

The lint screen is located under a lid on top of the dryer. **Clean it before each load.**

A screen blocked by lint can increase drying time.

To clean:

1. Open the lid and pull the lint screen towards you.



2. Roll lint off the screen with your fingers.



Do not rinse or wash screen to remove lint. Wet lint is hard to remove.

3. Push the lint screen firmly back into place and close the lid.

IMPORTANT:

- Do not run the dryer with the lint screen loose, damaged, blocked, or missing. Doing so can cause overheating and damage to both the dryer and fabrics.
- Some towels made of synthetic fibers and natural fibers (polyester and cotton blends) may shed more lint than other towels, causing your dryer's lint screen to fill up faster. Be sure to remove lint from the lint screen before and after drying new towels.

As needed cleaning

Laundry detergents and fabric softeners can cause a residue buildup on the lint screen. This buildup can cause longer drying times for your clothes, or cause the dryer to stop before your load is completely dry. Also, if lint falls off the screen, the screen is probably clogged.

Clean the lint screen with a nylon brush every six months or more frequently if it becomes clogged due to a residue buildup.

Use the following method:

1. Wet both sides of lint screen with hot water.
2. Wet a nylon brush with hot water and liquid detergent; scrub lint screen with the brush to remove residue buildup.

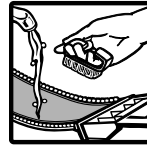

3. Rinse screen with hot water.
4. **Thoroughly** dry lint screen with a clean towel; replace in dryer.

Lint signal (on some models)

The lint signal (a whistle tone) indicates excessive lint is present on your lint screen. A full lint screen restricts airflow and reduces drying efficiency. When you hear the signal, stop the dryer and clean the lint screen.



NOTE: Clean your lint screen before each load. Do not wait for the lint signal.

Cleaning the dryer interior

Garments which contain unstable dyes, such as denim blue jeans or brightly colored cotton items, may discolor the dryer interior. These stains are **not** harmful to your dryer and will not stain future loads of clothes. It may be helpful to dry unstable dye items inside out to prevent dye transfer.

To clean dryer drum:

1. Make a paste with powdered laundry detergent and very warm water.
2. Apply paste to a soft cloth.

OR

Apply a liquid, non-flammable household cleaner to the stained area and rub with a soft cloth until all excess dye is removed.



3. Wipe drum thoroughly with a damp cloth.
4. Tumble a load of clean cloths or towels to dry drum.

! WARNING



Explosion Hazard

Use nonflammable cleaner.

Failure to do so can result in death, explosion, or fire.

Changing the drum light (on some models)

If your dryer has a drum light, it will be one of two types, as shown. The dryer light automatically turns on inside the dryer drum when you open the door.

⚠ WARNING



Fire Hazard

Replace light bulb cover before operating dryer.

Failure to do so can result in death or fire.

To change drum light type 1:

1. Unplug the dryer or disconnect the electricity leading to the dryer at the main power supply.
2. Open the dryer door. Remove the light bulb cover from the back wall of the dryer by turning the cover clockwise.

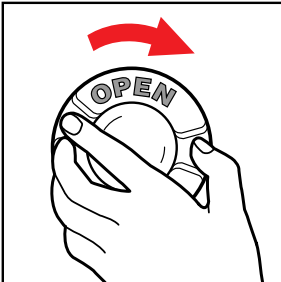

3. Remove the light bulb by turning it counterclockwise.
4. Replace the bulb with a 40-watt appliance bulb only.
5. Replace the light bulb cover and lock in place by turning counterclockwise.

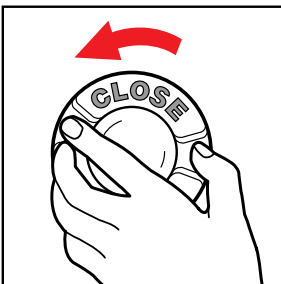

6. Reconnect power supply.

To change drum light type 2:

1. Unplug the dryer or disconnect the electricity leading to the dryer at the main power supply.
2. Open the dryer door. Remove the light bulb cover from the back wall of the dryer by removing the screw located in the lower right corner of the cover.

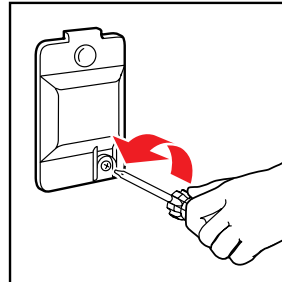

3. Remove the light bulb by turning it counterclockwise.
4. Replace the bulb with a 10-watt appliance bulb only.
5. Replace the light bulb cover.

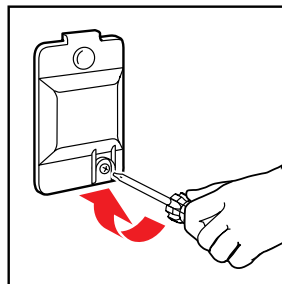

6. Reconnect power supply.

Removing accumulated lint

Lint can gather inside the dryer and be a fuel for fire. Lint should be removed every two to three years, or more often, depending on dryer usage. Cleaning should be done by a qualified person. If you have any questions or comments, please call our Consumer Assistance Center at **1-800-253-1301**.

⚠ WARNING



Electrical Shock Hazard
 Disconnect power before cleaning.
 Replace all panels before operating.
 Failure to do so can result in death or electrical shock.

For all electric dryers, or gas dryers which have a lower front access panel

NOTE: See page 18 if your dryer is gas and has a full front panel.

1. Unplug the power supply cord or turn off the electrical power.
2. Remove back panel (electric) or lower front access panel (gas). See the Installation Instructions.
3. Remove lint from shaded area in illustration with a soft brush or vacuum cleaner. Avoid damaging wires, thermostats (electric), funnel (gas), or ignitor (gas).
4. Replace panel.
5. Reconnect and level dryer again, if necessary.

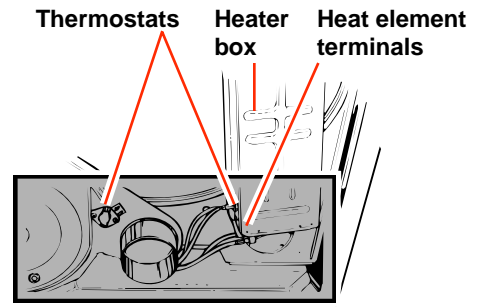

Electric dryer with back panel removed

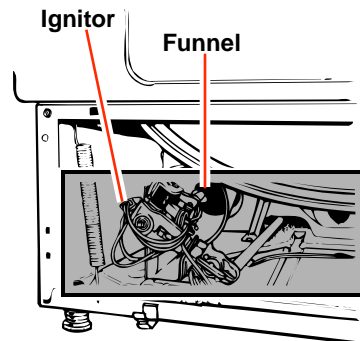

Gas dryer with lower front access panel removed

CARING FOR YOUR DRYER

If your dryer is gas and has a full front panel, remove front panel as follows:

1. Unplug the power supply cord or turn off the electrical power.
2. Open lint screen lid. Remove two screws from lint screen area.
3. Open top by pulling forward and up at each front corner (see View A). Rest raised top against wall behind dryer (top is hinged at rear).
4. Remove two internal screws from front panel flanges (near top front corners). Lift front panel slightly, lifting off lower clips (see lower clip inset of View B). Slowly pull front panel forward, disengaging panel from drum. (Drum will drop slightly.)

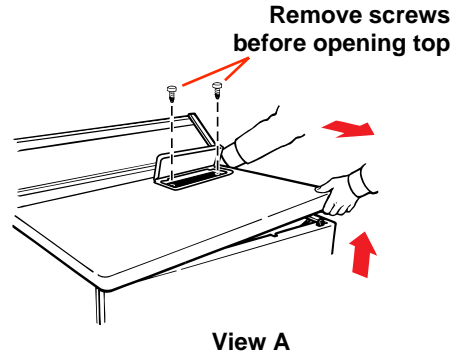

5. Move front panel aside and rest edge against side of dryer. Avoid disconnecting wire clips (see wire clips inset of View B) or damaging wires.
6. Remove lint from area shown in “gas dryer” illustration on page 17 with soft brush or vacuum cleaner. Avoid damaging wires, funnel, or ignitor.

7. Reassemble in reverse order. Before closing the top, check the following:
 - Drum seal must be flared out (see drum seal insets of View B) and properly positioned against panel at back of drum. Rotate drum counterclockwise one full turn to check drum seal.
 - Belt should be centered and tight on dryer drum.
 - Wire clip retainer, which holds the door switch wires, must be secured to top of front panel (see wire clips inset of View B) and along top edge of side panel. Door wires must not touch drum when dryer is operating.

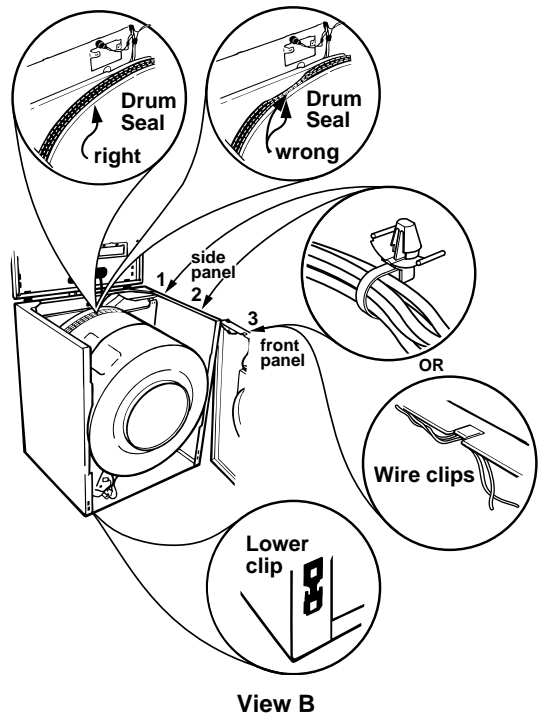

8. Replace top panel and lint screen screws. Top and front panels must be securely in place before operating dryer.
9. Reconnect power and level dryer again (if necessary).

For more information, call our
Consumer Assistance Center

1-800-253-1301

Laundry Tips

This section provides information on preparing clothes for drying, drying guidelines, and instructions for drying special-care items.

NOTES:

- Refer to your Washer Use and Care Guide for proper washing techniques and additional laundry tips.
- See pages 3 and 4 of this book for Important Safety Information.

Sorting clothes

- Separate dark from light colors; colorfast from non-colorfast. Items properly sorted for washing are usually properly sorted for drying.



- Separate heavy fabrics (denim, towels) from light fabrics (synthetics, permanent press).

- Separate lint givers (towels, chenille) from lint takers (corduroy, synthetics, permanent press). When possible, turn lint takers inside out.

Choosing load sizes

- Mix large items with smaller items. Load the dryer by the amount of space items take up, not by their weight. Do not overload the dryer. Overcrowding causes uneven drying and wrinkling, and can cause items to wear out faster (because of pilling).
- You may need to rearrange large items (sheets, blankets, tablecloths) during a cycle to reduce balling or rolling up.



- For better tumbling action, when drying only a few small items, add one or two lint-free towels. This also prevents small, lightweight items from blocking airflow.

Drying tips

- Close zippers, snaps, and hooks to avoid snagging other items. Remove heat-sensitive trim that can be damaged by drying. Tie strings and sashes so they will not tangle.
- Check garments to make sure all spots and stains were removed during the wash. Do not tumble dry soiled or stained items. Heat may permanently set stains.



- Sharp or metal objects can damage your dryer. Check pockets for pins, clips, money, bolts, nuts, etc. Do not lay these objects on your dryer after emptying pockets. Turn pockets of heavy items inside out for even drying.
- Place small items such as baby socks or hankies in a mesh bag for easier removal.
- Articles to be ironed should be removed from the dryer while still damp.



Using dryer fabric softener sheets

Dryer fabric softener sheets are recommended for reducing static cling and for softening fabrics. Always use fabric softener sheets labeled as dryer safe and follow package instructions carefully.

- Put one fabric softener sheet on top of the load **before starting the dryer**. Do not add a fabric softener sheet **after** the drying cycle has started. Instant heat can cause the fabric softener to spot fabrics.

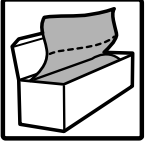

- Remove fabric softener stains by wetting the stains and rubbing them with liquid detergent or bar soap and rewash.
- Some fabric softener sheets can clog the lint screen and slow drying if used repeatedly. Use fabric softener sheets only once. Remember to remove the sheet with the load.

Saving energy

- Use an Automatic cycle to dry most loads.
- Dry only full loads without overdrying.
- Avoid overloading dryer, adding wet items to a partly dried load, or opening the door unnecessarily.
- Plan your laundry to dry one load after another. A warm dryer shortens drying time.
- Shorten drying times by exhausting dryer properly and cleaning exhaust duct and outside exhaust hood as needed.
 - Keep the lint screen clean.
 - Use your dryer in a room where room air temperature is above 45°F (7°C).
 - Sort loads by fabric weight and type.

Drying special-care items

Most garments and household textiles have manufacturer’s care labels with laundering instructions. **Always follow care label directions when they are available.** Pages 10 and 11 include drying instructions for most types of washables. The chart below provides drying instructions for special-care washables.

ITEMS	DRYING INSTRUCTIONS
<p>Blankets and woolens</p> <ul style="list-style-type: none"> • Cotton, rayon, synthetic blankets • Electric blankets, electric sheets, woolen blankets, washable woolen garments 	<p>Machine drying knitted woolens is not recommended. Block to shape when wet and allow to air dry. Line dry blankets in the shade on a breezy day over two lines. Pin edges together and straighten them. When partly dry, turn the blanket over, re-pin, and re-straighten. When dry, brush nap.</p> <p>Dry as recommended for permanent press fabrics on page 10.</p> <p>If manufacturer recommends machine drying:</p> <ol style="list-style-type: none"> 1. Place one or two dry towels in the dryer and preheat 3-5 minutes on a high setting. This will dry blankets faster and help avoid pilling. 2. Put blanket in dryer with warm towels. Set control for 20 minutes. 3. Check after 10 minutes. Remove when still damp. Overdrying and long tumbling can cause shrinking and pilling. 4. Place blanket on flat surface, or over two lines to finish drying. Gently stretch to original size and shape. 5. When completely dry, brush gently to raise nap. Press binding with cool iron if needed.
<p>Curtains, slipcovers</p> <ul style="list-style-type: none"> • Draperies, slipcovers 	<p>Remove drapery weights and hooks before laundering. For slipcovers, replace while still slightly damp. They will dry to fit tightly.</p> <p>Dry only a few minutes.</p> <ol style="list-style-type: none"> 1. Leave room in dryer for load to fluff. 2. Remove from dryer while slightly damp. Do not overdry.
<p>Diapers, baby clothes</p>	<p>Wash and dry small items in a mesh bag or pillowcase for convenient handling.</p> <p>Remove diapers and cotton knit items while still slightly damp. They will feel softer, shrink less, and be easier to fold.</p>
<p>Elastic items</p>	<p>Remove from dryer while still slightly damp.</p>
<p>Flame-retardant finishes</p>	<p>Some items have been treated with a flame-retardant finish to improve their resistance to burning. Such items are clearly labeled. To retain flame-retardant qualities through continuous use and washing, clean and dry according to the manufacturer’s instructions.</p>

continued on next page

LAUNDRY TIPS

ITEMS	DRYING INSTRUCTIONS
Napped items <ul style="list-style-type: none">• Corduroy, velveteen	Dry separately or with similar colors to avoid lint transfer. Follow care label instructions. <ol style="list-style-type: none">1. Remove from dryer while there is still a trace of moisture.2. Smooth, reshape, and air dry before putting away.
Quilted, down-filled items	Follow care label instructions. <ol style="list-style-type: none">1. Dry one at a time.2. Remove from dryer and shake or fluff the item during the drying cycle.3. Smooth and reshape before putting away.
Snowsuits, jackets <ul style="list-style-type: none">• Nylon or polyester	Check label for fiber content, then follow care label instructions. <ol style="list-style-type: none">1. Dry garment for about 10 minutes. Remove and turn inside out. Dry for 10 more minutes.2. Remove from dryer immediately and hang on a non-rusting hanger to finish drying. This will help eliminate wrinkles.
Synthetic items	Dry these items inside out to avoid pilling.
Washable knits	Do not overdry knits. Overdrying can cause shrinking and static cling. <ol style="list-style-type: none">1. Select cycle according to fabric and construction.2. Turn synthetics and blends inside out when drying to avoid pilling.3. Remove cotton and rayon knits while still slightly damp. Stretch into shape and lay flat to finish drying.

Troubleshooting

Most laundering problems are easily solved if you understand the cause. Check the following list for common **laundry** problems and the next page for common **dryer** problems. If you need further assistance, see “Requesting Assistance or Service” on page 25.

Common laundry problems

PROBLEM	CAUSE
Greasy spots	<ul style="list-style-type: none">• Dryer fabric softener improperly used. See manufacturer’s directions.• Drying soiled items.
Lint	<ul style="list-style-type: none">• Full lint screen. (See page 14.)• Load not properly sorted.• Overdrying, especially synthetic fabrics that cause lint-attracting static electricity.• Load size too big or heavy.• Tissue or paper left in pockets.• Pilling (surface fuzz caused by normal wear and laundering) attracts lint.
Shrinking	<ul style="list-style-type: none">• Overdrying.• Fabric type and quality inappropriate for drying.• Dryer settings incorrect for fabric type.• Manufacturer’s care label instructions not followed.
Slow drying or clothes still wet	<ul style="list-style-type: none">• Full or clogged lint screen. (See page 14.)• Load too large and bulky to dry quickly.• Dryer located in room with temperature below 45°F (7°C).• Exhaust duct clogged, restricted, or too long.
Stains	<ul style="list-style-type: none">• Drying soiled items.• Dryer fabric softener improperly used. See manufacturer’s directions.• Dryer interior stained. (See page 15 for cleaning procedures.)
Static electricity	<ul style="list-style-type: none">• Overdrying.• Dryer fabric softener improperly used. See manufacturer’s directions.• Load includes synthetics, synthetic blends, permanent press, and knit fabrics that build up static electricity.
Wrinkling	<ul style="list-style-type: none">• Overloading.• Overdrying, especially permanent press, and synthetic fabrics.• Clothes left in dryer at end of cycle.

TROUBLESHOOTING

Common dryer problems

Before calling for service, check these:

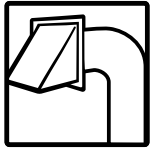

Is exhaust duct or outside exhaust hood clogged with lint?

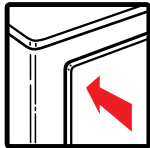

Is the dryer door firmly closed?

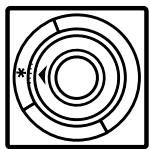

Are the controls set in an ON position?



Did you firmly push the Start Button?



Is lint screen clogged with lint?

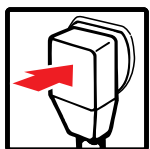

Is the power cord plugged in?



Have you blown a fuse or tripped a circuit breaker?
Electric dryers use 2 household fuses (or breakers). The drum may be turning but you may not have heat.

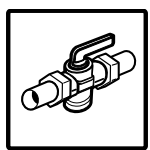

For gas dryers, are the valves open on the dryer and the supply line?



Is the lint signal sounding (on some models)?

If you still have problems, see "Requesting Assistance or Service" on page 25.

Requesting Assistance or Service

Before calling for assistance or service, please check “Troubleshooting” on pages 23-24. It may save you the cost of a service call. If you still need help, follow the instructions below.

1. If you need assistance* ...

Call the Whirlpool Consumer Assistance



**Center telephone number.
Dial toll-free from anywhere
in the U.S.A.:**

1-800-253-1301

and talk with one of our trained consultants. The consultant can instruct you in how to obtain satisfactory operation from your appliance or, if service is necessary, recommend a qualified service company in your area.

If you prefer, write to:

Whirlpool Brand Home Appliances
Consumer Assistance Center
c/o Correspondence Dept.
2000 North M-63
Benton Harbor, MI 49022-2692

Please include a daytime phone number in your correspondence.

2. If you need service* ...

Whirlpool has a nationwide network of authorized Whirlpool service companies. Whirlpool service technicians are trained to fulfill the product warranty and provide after-warranty service, anywhere in the United States. To locate the authorized Whirlpool service company in your area, call our Consumer Assistance Center telephone number (see Step 1) or look in your telephone directory Yellow Pages under:



**• APPLIANCE-HOUSEHOLD-
MAJOR, SERVICE & REPAIR**

- See: Whirlpool Appliances or
Authorized Whirlpool Service
(Example: XYZ Service Co.)

**• WASHING MACHINES &
DRYERS, SERVICE & REPAIR**

- See: Whirlpool Appliances or
Authorized Whirlpool Service
(Example: XYZ Service Co.)

3. If you need FSP® replacement parts ...

FSP is a registered trademark of Whirlpool Corporation for quality parts. Look for this symbol of quality whenever you need a replacement part for your WHIRLPOOL® appliance. FSP replacement parts will fit right and work right, because they are made to the same exacting specifications used to build every new WHIRLPOOL appliance.

To locate FSP replacement parts in your area, refer to Step 2 or call the Whirlpool Consumer Assistance Center number in Step 1.

4. If you are not satisfied with how the problem was solved ...

- Contact the Major Appliance Consumer Action Program (MACAP). MACAP is a group of independent consumer experts that voices consumer views at the highest levels of the major appliance industry.
- Contact MACAP only when the dealer, authorized servicer, and Whirlpool have failed to resolve your problem.

Major Appliance Consumer Action Program
20 North Wacker Drive
Chicago, IL 60606

- MACAP will in turn inform us of your action.

* When asking for help or service:

Please provide a detailed description of the problem, your appliance's complete model and serial numbers, and the purchase date. (See page 2.) This information will help us respond properly to your request.

Index

This index is alphabetical. Look for the word or phrase you want, and then look for the page number.

TOPIC	PAGE	TOPIC	PAGE
AIR DRYING	11	FLUFF AIR cycle	8
AUTOMATIC cycles	8	HEAVY DRY cycle	8
CARE/CLEANING		LINE DRYING	11
Dryer interior	15	LINT	
Lint screen	14	Screen	14
CHOOSING LOAD SIZES	19	Removal	17
CYCLES	8-9	Signal	15
DAMP DRY cycle	8	LOAD	
DRUM LIGHT, Changing	16	Size	19
DRYER		Sorting	19
Fabric softeners	20	RACK DRY	
Features	5	Feature	9
Restarting	7	Using	13
Safety	3-4	SAFETY	3-4
Starting	6	SELECTING CYCLE/SETTING	7
Stopping	7	SERVICE	25
DRYING		SORTING LOAD	19
Cycles chart	10	START BUTTON	7
Rack	13	TEMPERATURE SELECTOR	7, 10
Special-care items	21	TIMED cycles	8-9
Tips	19	TOWELS feature	9
END OF CYCLE signal	12	TROUBLESHOOTING	
ENERGY		Dryer problems	24
Preferred setting	6, 8	Laundry problems	23
Saving	20	TUMBLE PRESS® cycle	9
FINISH GUARD®		WARRANTY	28
Feature	9		
Selector	12		

WHIRLPOOL® Dryer Warranty

LENGTH OF WARRANTY	WHIRLPOOL WILL PAY FOR
FULL ONE-YEAR WARRANTY FROM DATE OF PURCHASE	FSP® replacement parts and repair labor to correct defects in materials or workmanship. Service must be provided by an authorized Whirlpool service company.
WHIRLPOOL WILL NOT PAY FOR	
<p>A. Service calls to:</p> <ol style="list-style-type: none"> 1. Correct the installation of your dryer. 2. Instruct you how to use your dryer. 3. Replace house fuses or correct house wiring or plumbing. 4. Replace light bulbs. <p>B. Repairs when your dryer is used in other than normal, single-family household use.</p> <p>C. Pickup and delivery. Your dryer is designed to be repaired in the home.</p> <p>D. Damage to your dryer caused by accident, misuse, fire, flood, acts of God, or use of products not approved by Whirlpool.</p> <p>E. Repairs to parts or systems caused by unauthorized modifications made to the appliance.</p>	

6-94

WHIRLPOOL CORPORATION SHALL NOT BE LIABLE FOR INCIDENTAL OR CONSEQUENTIAL DAMAGES. Some states do not allow the exclusion or limitation of incidental or consequential damages, so this exclusion or limitation may not apply to you. This warranty gives you specific legal rights, and you may also have other rights which vary from state to state.

Outside the United States, a different warranty may apply. For details, please contact your authorized Whirlpool dealer.

If you need service, first see the "Troubleshooting" section of this book. After checking "Troubleshooting," additional help can be found by checking the "Requesting Assistance or Service" section or by calling our Consumer Assistance Center telephone number, **1-800-253-1301**, from anywhere in the U.S.A.